

TOTAL SOLUTIONS™



# TOTAL SPEAKER SOLUTIONS

TSS-SAT1200  
Owner's Guide



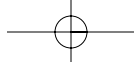

# TSS-SAT1200 OWNER'S GUIDE

## Table of Contents

- 3 Introduction
- 3 Included
- 3 Planning Your System
- 3 Placement
- 4 Wall-Mounting the Satellites
- 6 Connections
- 6 Maintenance and Service
- 7 Specifications

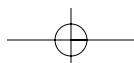
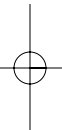
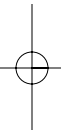

## INTRODUCTION

### Infinity Total Solutions™

Infinity Total Solutions continues Infinity's longstanding commitment to accurate sound reproduction. Our high-quality drivers, precision dividing networks and rigid, well-braced enclosures combine to deliver uncompromised performance in any multichannel home theater system. In addition, the TSS-SAT1200 is magnetically shielded for safe placement adjacent to a television.

## INCLUDED

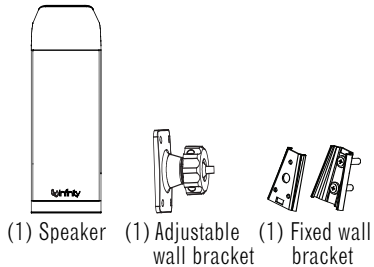

## PLANNING YOUR SYSTEM

Before deciding where to best place your speakers, survey your room and study Figures 1 and 2.

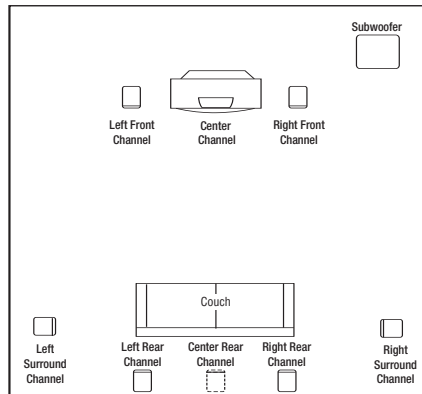

Figure 1. This overhead view shows a typical home theater plan. Left/right rear channels are for a 7-channel system. Center rear channel is for a 6-channel system.

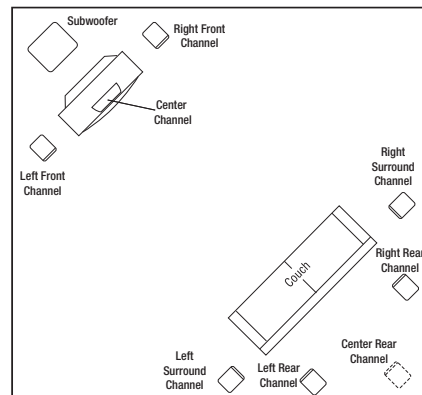

Figure 2. This figure shows an alternate layout, which may be more suitable for some rooms. Left/right rear channels are for a 7-channel system. Center rear channel is for a 6-channel system.

## PLACEMENT

**NOTE:** The TSS-SAT1200 can be placed directly on a shelf, or mounted on a wall using the included wall brackets.

### As Left and Right Front Channels

For left and right front channels, place one satellite to the left and another to the right of the television, as shown in Figure 1. Since the speakers are magnetically shielded, you can place them very close to the TV without worrying about the magnetic field distorting the picture.

### As Surround Channels

For left and right surround channels, place one speaker on the left and another on the right, to the side of or slightly behind the listening area. The surround speakers should be mounted at a height of between 5 ft. (1.5m) and 7 ft. (2m).

In 6- or 7-channel configurations, place the rear channel(s) behind the listening position, as shown in Figures 1 and 2.

**NOTE:** An Infinity powered subwoofer will add impact and realism to both music and film soundtracks. Contact your Infinity dealer for recommendations on subwoofer models for your application.

### Mounting on Floor Stands

An optional floor stand is available, should you prefer to place your TSS-SAT1200 satellites on the floor; see your dealer or visit [www.infinitysystems.com](http://www.infinitysystems.com) for more information.

## WALL-MOUNTING THE SATELLITES

TSS-SAT1200 satellites are designed to also be mounted on the wall. There is a fixed-mount wall bracket and an adjustable wall bracket provided for each satellite. Each speaker bracket will require up to four 1-1/2" #10 wood screws; each screw should be fastened to a wall stud. If a wall stud is unavailable, install an anchor appropriate for a 1-1/2" #10 screw.

**IMPORTANT SAFETY NOTE:** The customer is solely responsible for proper selection of mounting hardware not included with the speakers, and for proper assembly and installation of the wall brackets, including but not limited to the selection of appropriate weight-bearing supports and proper use of the bracket. Infinity disclaims any liability for the selection of mounting hardware and/or bracket installation. Be sure to follow these bracket assembly and installation instructions carefully. If you have any questions or doubts about your ability to correctly wall-mount the speakers, consult with your authorized Infinity dealer or custom installer.

### Fixed-Mount Wall Bracket

**Step 1.** Remove the rear foot by loosening the screw on the bottom of the satellite.

**Step 2.** Mark the positions on the wall where you would like to place the mounting screws.

**Step 3.** Attach the back plate of the bracket to the wall using three screws (not included).

**Step 4.** Attach the front plate (with the spring tab) of the bracket to the satellite, using the provided screws.

**Step 5.** Slide the satellite speaker with attached bracket front plate onto the back plate of the bracket until the tab locks into place.

To remove the speaker from the wall, simply push in the locking tab and slide the speaker up.

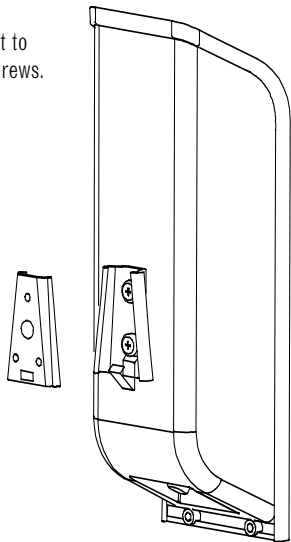

### Adjustable Wall Bracket

**Step 1.** Remove the rear foot by loosening the screw on the bottom of the satellite.

**Step 2.** Mark the positions on the wall where you would like to place the mounting screws.

**Step 3.** Place bracket against the wall and fasten four 1-1/2" #10 wood screws through the bracket's screw holes into the wall. If a wall stud is not available, use an appropriate anchor.

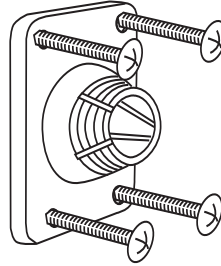

**Step 4.** Unscrew round collar (C) from bracket (A).

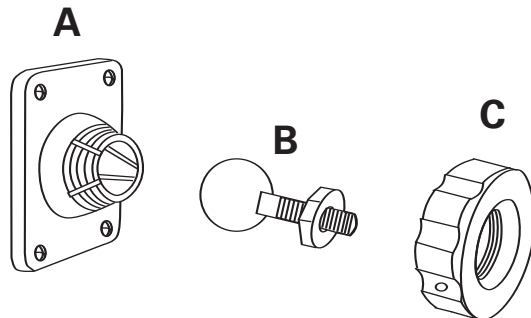

**Step 5.** Screw the ball and shaft assembly (B) to the lower 1/4"-20 insert on the rear of the satellite, until it is fully seated. Back out 1/2 of a turn and tighten the nut against the speaker. Securely tightening this nut against the speaker enclosure is very important; otherwise, performing Step 7 may dislodge the threaded insert on the speaker enclosure, rendering it unusable.

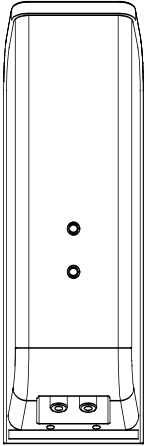

**Step 6.** Attach speaker wire as shown on page 7.

**Step 7.** Drop round collar (C) over ball and shaft assembly (B) that is mounted to the speaker with the finished side of the collar facing the rear of the speaker.

**Step 8.** Carefully push the ball straight into the socket mounted on the wall, angle the speaker as desired and tighten the collar using the enclosed metal bar.

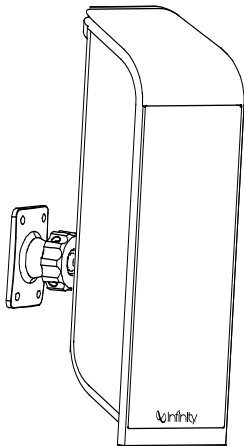

Figure 3. Bracket on wall.

## CONNECTIONS

After placing the speakers, you are ready to connect your system. First, turn off all audio system power. Use high-quality speaker wire to make your connections; #18-gauge speaker wire with polarity coding is recommended. For longer distances, #16-gauge or heavier wire is recommended. The side of the wire with a ridge or other coding is usually considered positive polarity (i.e., +). Also, consult the owner's manuals that were included with your amplifier or receiver to confirm connection procedures. Observe polarities when making speaker connections, as shown in Figure 4. Connect each + terminal on the back of the amplifier or receiver to the respective + (red) terminal on each speaker. Connect the – (black) terminals in the same way.

### Important!

Do not reverse polarities (i.e., + to –, or – to +) when making connections. Doing so will cause poor imaging and diminished bass response. Be certain that positive and negative wire strands are completely isolated to avoid short circuits that may damage your equipment.

## MAINTENANCE AND SERVICE

The TSS-SAT1200 enclosure may be cleaned using a soft cloth to remove fingerprints or to wipe off dust.

All wiring connections should be inspected and cleaned or remade periodically. The frequency of maintenance depends on the metals involved in the connections, atmospheric conditions and other factors, but once per year is the minimum.

If a problem occurs, make sure that all connections are properly made and clean. If a problem exists in one loudspeaker, reverse the connection wires to the left and right system. If the problem remains in the same speaker, then the fault is with the loudspeaker. If the problem appears in the opposite speaker, the cause is in another component or cable. In the event that your TSS-SAT1200 ever needs service, contact your local Infinity dealer or distributor, or visit [www.infinitysystems.com](http://www.infinitysystems.com) for a service center near you.

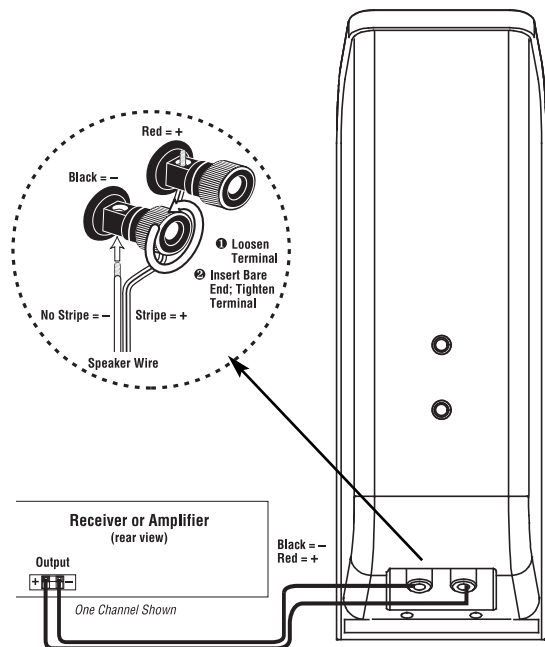

Figure 4. Wiring diagram shows polarity connections for one channel of a home theater system (rear foot not shown, for the sake of clarity).

## SPECIFICATIONS

### TSS-SAT1200

<b>Frequency Range:</b>	120Hz – 30,000Hz ( $\pm 3$ dB)
<b>Recommended Amplifier Power Range:</b>	10 – 125 Watts
<b>Sensitivity:</b> (2.83V @ 1 meter)	89dB
<b>Nominal Impedance:</b>	8 $\Omega$
<b>Crossover Frequency:</b>	3.5kHz; 24dB/octave
<b>Midrange Driver(s):</b>	Dual 3-1/2" (64mm) MMD <sup>®</sup> magnetically shielded
<b>High-Frequency Driver:</b>	3/4" (19mm) MMD magnetically shielded
<b>Dimensions (H x W x D):</b>	12-15/16" x 3-15/16" x 3" (329mm x 100mm x 76mm)
<b>Weight:</b>	3.9 lb (1.8kg)

Infinity continually strives to update and improve existing products, as well as create new ones. The specifications and construction details in this and related Infinity publications are therefore subject to change without notice.

#### Declaration of Conformity



We, Harman Consumer Group International  
2, route de Tours  
72500 Château du Loir  
France

declare in own responsibility that the product described  
in this owner's manual is in compliance with technical  
standards:

EN 61000-6-3:2001  
EN 61000-6-1:2001

Laurent Rault  
Harman Consumer Group International  
Château du Loir, France 8/06

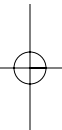
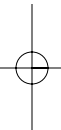
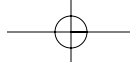

TECHNOLOGY • PERFORMANCE • DESIGN

© 2006 Harman International Industries, Incorporated. All rights reserved.

Infinity Systems, 250 Crossways Park Drive, Woodbury, NY 11797 USA [www.infinitysystems.com](http://www.infinitysystems.com)

Infinity, Harman International and MMD are trademarks of Harman International Industries, Incorporated, registered in the United States and/or other countries.

Total Solutions is a trademark of Harman International Industries, Incorporated.

Part No. 406-000-05483-E 8/06

**H** A Harman International® Company

